

SURE • SEAL™

(PATENTED)

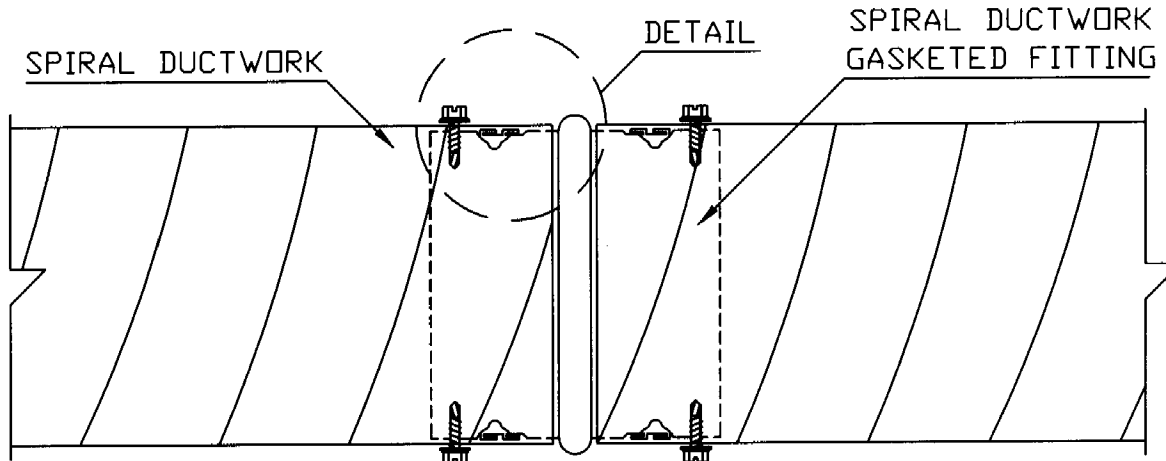

SURE SEAL™ DETAIL
SINGLE WALL SPIRAL DUCTWORK

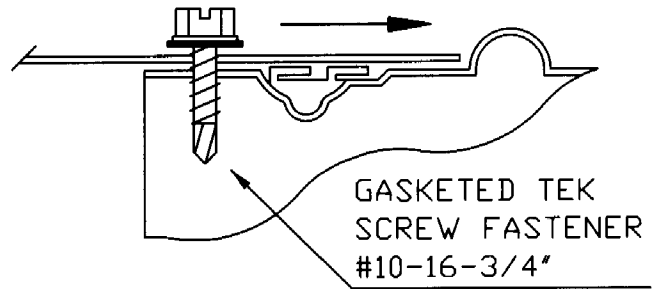
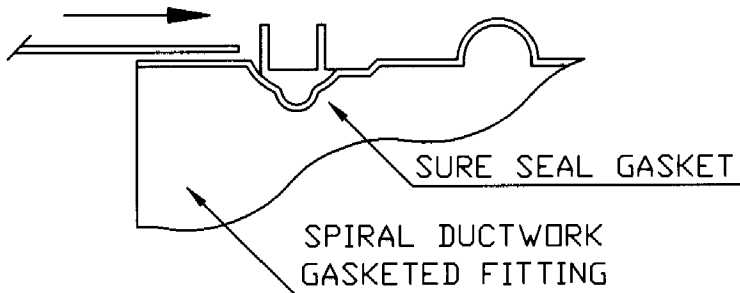

SURE SEAL™ DETAIL
DOUBLE WALL SPIRAL DUCTWORK

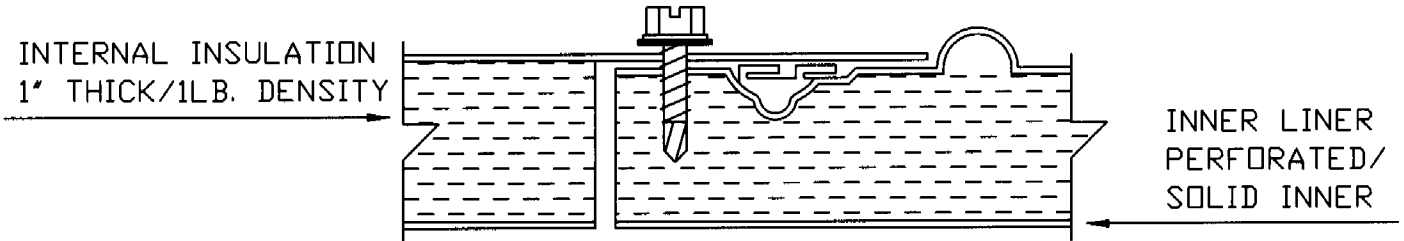

PROFILE
EPDM RUBBER GASKET

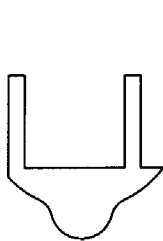
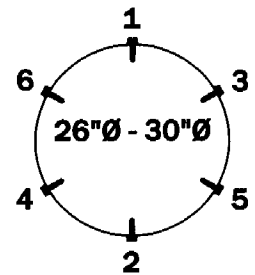
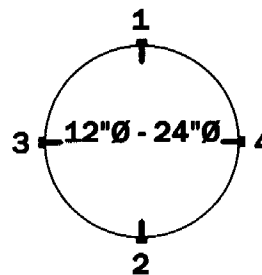
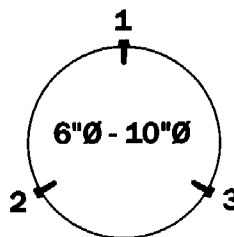
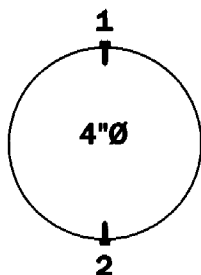

DIAGRAM BELOW SHOWS TEK SCREW
QUANTITY AND PLACEMENT SEQUENCE



www.langdonsheetmetal.com

Cincinnati, Ohio. 45215
The above mentioned product, is protected by pending patents and trade marks
All Rights Reserved updated 3/7/13

Sure Seal Spiral Aluminum Specifications

A. General : Fabricate single wall ducts, elbows, transitions, offsets, branch connections, and other construction according to SMACNA's "HVAC Duct Construction Standards - Metal and Flexible" and complying with requirements for metal thickness and minimum gauge as shown, reinforcing types and intervals, and joint intervals per static pressure class indicated.

1. Lengths : Fabricate round ducts in lengths appropriate to reinforcement and rigidity class required for pressure class. 10'-0" maximum lengths.
2. Deflection : Duct systems shall not exceed deflection limits according to SMACNA's "HVAC Duct Construction Standards - Metal and Flexible".
3. Round Fittings : Fabricate fittings to match adjoining ducts, and to comply with duct requirements as applicable to fittings. Provide fitting types as indicated on drawings.
4. Round Elbows : Except as otherwise indicated, fabricate elbows with center-line radius equal to 1-1/2 times associated duct width. Where installation requirements prevent the use of fitting types indicated on the drawings and/or with center-line radius equal to 1-1/2 times the duct width, provide center-line radius equal to 1 times the duct width.
5. Ductwork leakage rates not to exceed 2 cfm per 100 square feet at 10" W.G. positive pressure.

B. Material :

1. Aluminum 3003-H14

C. Minimum Fittings Gauge (2" W.G. positive pressure) :

1. Fitting : 4" to 14" diameter - .032 Gauge
 16" to 26" diameter - .040 Gauge
 28" to 30" diameter - .050 Gauge

D. Longitudinal Seams :

1. Ductwork Seams : (RL-1) Spiral Seam.
2. Fittings Seams : (RL-2) Lap and rivet or tack weld on 6" interval.
3. Seal seams in accordance with SMACNA's HVAC Duct Construction Standard - Metal and Flexible.

E. Transverse Joints: Integral gasketed ductwork system.

1. Manufacturer :

Langdon Inc.
9865 Wayne Ave Cincinnati, Ohio 45215
Phone (513)733-5955 ext.238 Fax (513)733-8050
www.langdonsheetmetal.com
Attn. : Joe Sandman. Mobile # 513-678-6825

- a. Sure-Seal Spiral, even sizes 4" diameter to 30" diameter.
- b. Slip Joint Connection : Continuous machine formed groove with gasket.
- c. Gasket : EPDM rubber with a dual lipped profile. Temperature range : -20 F to +200 F.
- d. Secure joint with gasketed #10-16-3/4" tek screw as recommended by manufacturer.